

DESCRIPTION

Wintergarden shading system Type 5267, 45WT electric control, 2part drapery

- straight or single curved rail
- bending radius minimal 350 mm
- drapery qualities according to collection
- width of rail max. 2500 mm,
- length of rail max. 8000 mm
- fabric weight 310 g/m²
- mounting horizontal or slightly sloped
- distance of telescopic rods appr. 400 mm

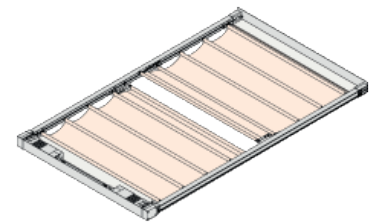

DATA AND FEATURES

Rail

width 32 mm, height 26 mm

made of extruded aluminium AlMgSi 0.5 F22

technically anodized as per E6/EV1 or white powder coated according to RAL 9016

plastic parts either white or grey



Gear

ball-bearing rail gear on both sides

motor with end position fixing, right or left, free of choice

Electro controls

single phase AC synchronous motors, 45 WT

integrated end position switch which can be set from outside

simply attachable to the rail gear by bayonet joint

running speed 130 mm/s

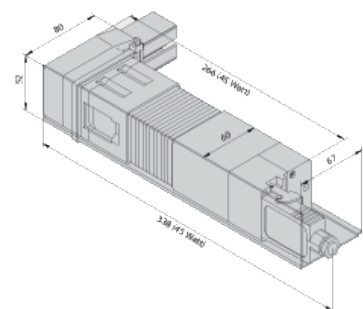

rated voltage	230 V	110 V
rated consumption	45 W	45 W
rated current	0,13 A	0,26 A
frequency	50 Hz	60 Hz
operating mode	S3 50%	S3 50%
direction of rotation	right+left	right+left

Suitable for dry areas only.

Transportation tape

toothed belt with special contour and coating
constant length and resistant to wear
very smooth and calm run

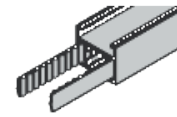

Drive runner

drive runner, wear-resistant plastic slide, special steel traverse joint, safety clip

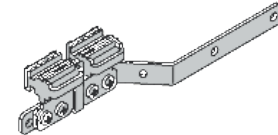

Runner and Telescopic Rod

double axle runners with galvanized steel axle
special running wheels guarantee a smooth run
telescopic rod with tension spring inserted in drapery
telescopic rods can be easily hung and removed due to locking bushes



Mounting

easy and quick mounting with locking bolt
ceiling mounting with adjustable mounting angles

USAGE

electro control via touch pushbutton switch or radio remote control, single control, group or central control